

VS
TAL



PRODUCT INFORMATION

VS GATE FAMILY

**LOSING YOURSELF
INSIDE**

VS

**OPENING THE DOOR
TO NEW POSSIBILITIES**

Create more than 1,000 new options with just a few parts: this is possible thanks to the expansion of the existing **VS TAL® Gate** module to include **VS Gate Rack** and **VS Gate Rack Plus** and the new maxi tray **VS TAL® Gate C 750**.

The new elements now offer more scope for individual solutions – in the cabinet and beyond.



■ VS GATE RACK \ VS GATE RACK PLUS



Frame for door widths C 450 and 500, as well as for C 600

Available in heights H1, H3 and H5

Elements can be positioned freely irrespective of VS TAL® or VS SUB® category

With force dispersal, as a stand-alone and as a fixture solution

A CONVERTIBLE BASIC FRAMEWORK

The **VS Gate Rack** can be used both as a cabinet door shelf and as a wall shelf. When combined with the **VS TAL® Gate** family, the result is the tall-cabinet **VS Gate Rack Plus** with the **VS TAL® Gate Pro**.

VS Gate Rack

Stand-alone
Can be used as wall hanging shelf,
cabinet door shelf or cabinet wall shelf

C 600

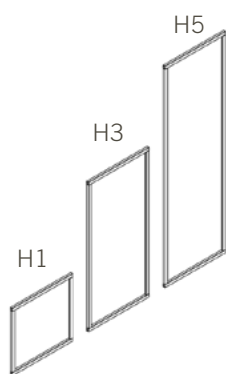

C 450 & 500

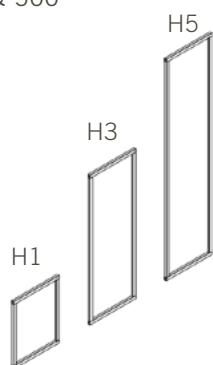

VS Gate Rack Plus

With force dispersal
Can only be used as cabinet door shelf

C 600

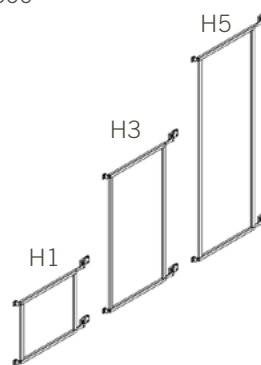

C 450 & 500

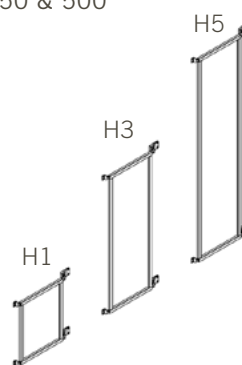

Dimensions (without fixture elements)

C 450 / C 500

H1: 421 x 330
H3: 933 x 330
H5: 1381 x 330

C 600

H1: 421 x 435
H3: 933 x 435
H5: 1381 x 435

Benefits at a glance

- Elements can be positioned freely irrespective of **TAL®** oder **SUB®** category
- Available in the heights **H1**, **H3** and **H5**
- For door widths **C 450**, **C 500** and **C 600**
- VS Rack Plus**: with force dispersal, as a stand-alone and as a fixture solution

A FAMILY WITH MANY FACES

The door-coupled VS Gate products are already among the best systems in the world currently in production. The modular tall-cabinet solutions bring fresh perspectives to any kitchen. Developed for maximum storage space and easy access, the modular system sets new standards both in terms of comfort and in its design.

The real benefit of VS Gate is its opening mechanism. It automatically brings all stored items to the user in one

go and facilitates an optimal overview.

The new design – reduced to the essential – is characterised by invisible connections. At the same time, unnecessary plastic parts were dispensed with to improve sustainability.

An array of application variants and cross-selling options are available with just a few elements as a design combination.

The VS Gate components

VS Gate Pro (in combination with VS TAL® Gate)
VS Gate Rack (as stand-alone)



VS Gate Pro Front Tray



VS Gate Follower



VS Gate Frame

VS Gate Pro Plus (in combination with VS TAL® Gate)
VS Gate Rack PLUS (as stand-alone)



VS Gate Flex



VS Gate Pro Rear Tray



VS Gate Tray

VS Gate Runner Set





WELL COMBINED – BETTER ARRANGED

VS Gate and VS TAL® Gate be used and combined in a variety of ways. The result is individual storage solutions both inside and outside the cabinet.



or



VS Gate Rack
Cabinet installation

VS Gate Rack
Wall installation



VS Gate Flex

VS Gate Rack Plus



VS Gate Rack Plus
Cabinet door installation

VS TAL® Gate

VS TAL® Gate Pro

THE IDEAL FRAME FOR MORE STORAGE

The **VS TAL® Gate Frame** in the three widths C 450, 500 and 600 offers a universal foundation and bearing structure for **VS TAL® Gate** and the expansion **VS TAL® Gate Pro**. The frame set is also available with adapters to lock a visible back panel as an optional extra.

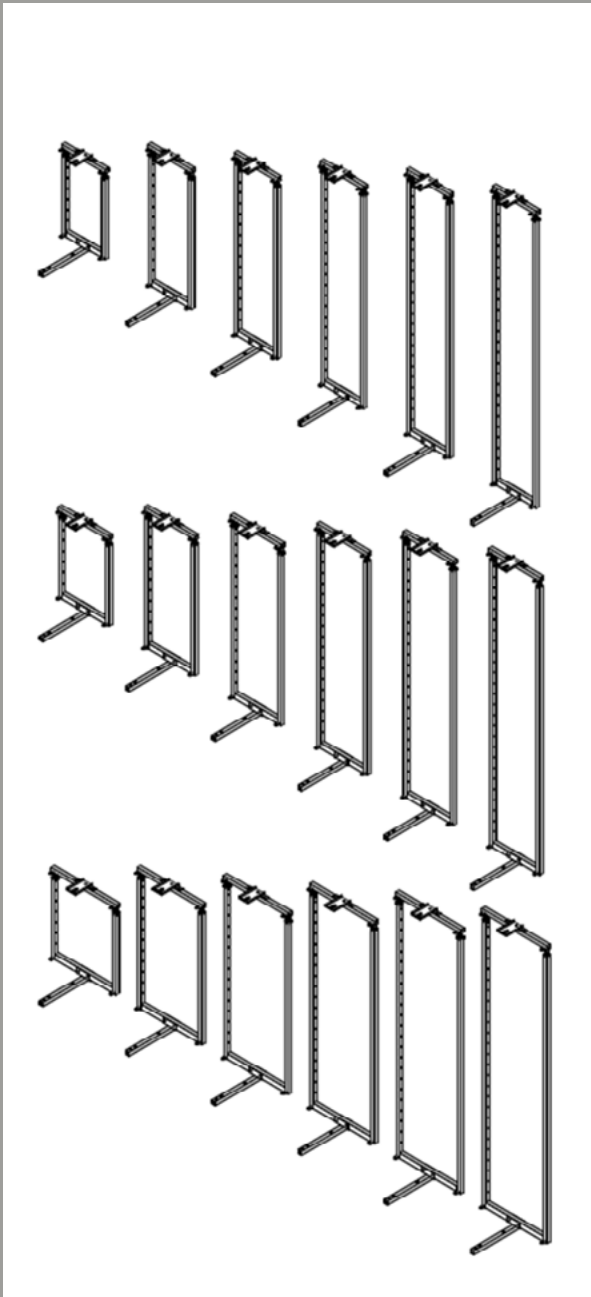

VS TAL® Gate Frame

C 450



VS TAL® Gate Pro

C 500

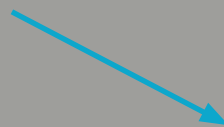

VS TAL® Gate

C 600

THE FOUNDATION FOR OVERVIEW AND ORDER

VS TAL® Gate Tray
VS TAL® Gate Pro Rear Tray
VS TAL® Gate Pro Front Tray

The rear- and front-mounted tray elements offer various possible combinations. Depending on the positioning and dimensions of the **VS TAL® Gate Pro**

variant's front frame, use of the depth-reduced Rear Trays is possible alongside full-depth classic Gate Trays in the lower section.

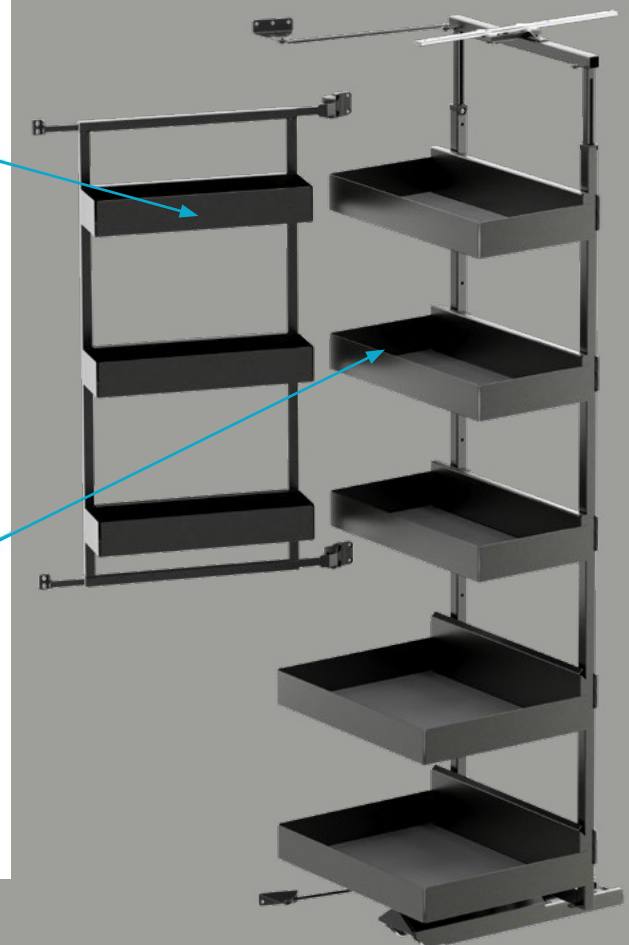
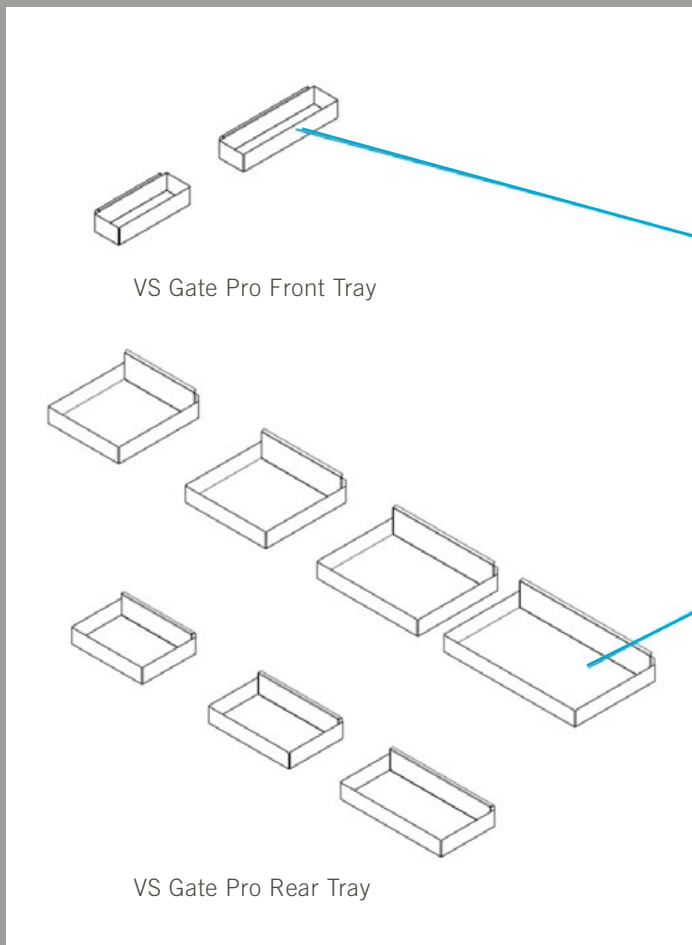

VS TAL® Gate Pro



55%
MASON & CO

65%
MASON & CO

70%
MASON & CO

HIGHEST QUALITY
PASTA

RISOTTO

TRIO SANGRE

HIGHEST QUALITY
PASTA

COFFEE

COFFEE
HOUSE

100% ARABICA

■ VS TAL® GATE ADDITIONAL LAYOUT \ VS GATE FLEX



EXTRA VERSATILE – EXTRA FLEXIBLE

VS Gate Flex

Each of the **4 neuen VS Gate Flex Elemente** (Tray H0, Frame, Roll, Hook) supplements the basic tray **VS Gate Pro Front Tray** for the widths C 450–500 and C 600. They offer a wide range of fantastic interior organisation possibilities.

The **VS Gate Pro Front Tray** and the **VS Gate Flex** elements integrate into the new modular frame concept both inside

and outside without visible connections.

Can be used for both the **VS Gate Rack** and the **VS TAL® Gate Pro**.

The design and dimensions are coordinated with the **VS ADD® Box** and **VS ADD® Separator** elements to form a modular unit and offer a variety of options.

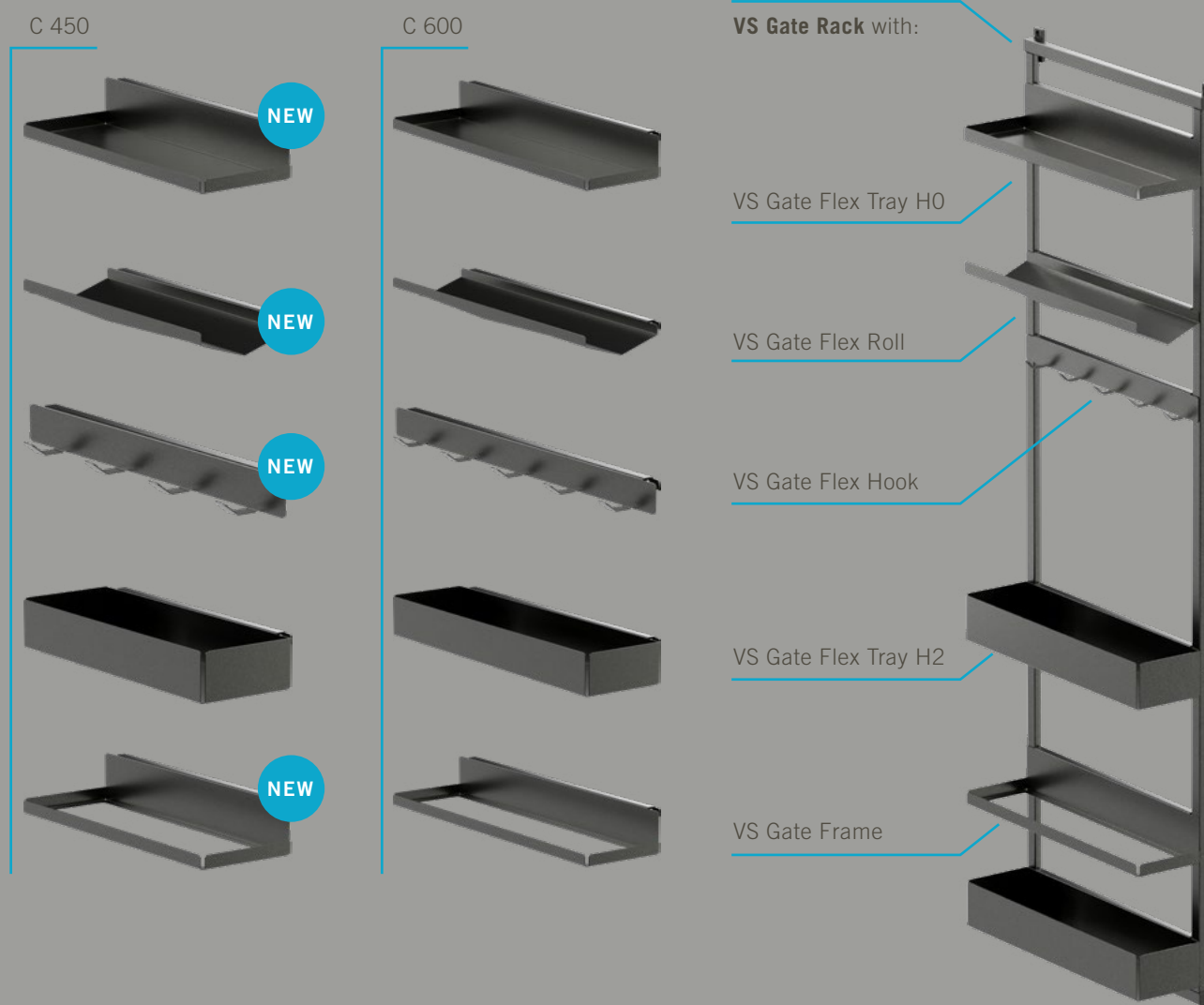

POSSIBLE APPLICATIONS \ VS GATE FAMILY





APPLICATION IN DETAIL

VS Gate Rack (450-500)

The frame of the **VS Gate Rack** can also be perfectly positioned inside the corpus in the narrow variant (**C 450-500**).

The depth is designed such that it can be fixed behind the hinge level for conventional interior depths. It retains the feature of flexible equipment options.

Design and tray depths have been developed for interior organisation using the **VS ADD® Box** and **VS ADD® Separator**. They underscore the system's new modular characteristics.

VS Gate Rack wall installation

The simplest application for the **VS Gate Rack** is wall mounting on the wall brackets, which were specially designed for this purpose.

The extra-thin frame boasts a special profile. This allows the invisible locking of flexible tray elements without additional plastic adapters, thus underscoring the minimalistic design.

The 64 mm grid steps facilitate tray element positioning that is perfectly adapted to the storage space. They can be adjusted straight-forwardly and without tools.



VS Gate Rack

VS Gate Rack plus

Based on the same frame as for the **VS Gate Rack**, slide bearings with flexible force dispersal are used in the corpus rather than a wall retainer. This facilitates placement on the inside of the door.

The variant for **C 450**, **C 500** or **C 600** is used depending on the width of the door. It offers secure storage on the inside of the door without putting too much strain on the hinges.



VS Gate Rack plus

VS TAL® Gate

The tried-and-tested **VS TAL® Gate** fixture is retained as the main module. The door follower ensures the automatic exit motion of the trays when the door opens.

In the **VS TAL® Gate**, the trays are retained to the full depth. The new maxi tray C 750 is based on the tried-and-tested C 600 **TAL® Gate Frames**. It takes into account the current trend for wider door fronts.



C 600

C 750

VS TAL® Gate Pro

Combining the **VS TAL® Gate** and **VS Gate Rack Plus** results in the **VS TAL® Gate Pro**, the most complete system solution.

In the complete design, the modular tray elements in the **VS Gate Pro Front Trays** and the depth-reduced tray **VS Gate Pro Rear Tray** are used.

And of course, the modular principle is applied here too, meaning that the front trays can also be fitted with **VS Gate Flex** elements.



VS TAL® Gate Pro

VS TAL® Gate Pro reduced height

A further application variant can also be created with a reduced frame height, offering a convenient system solution.

In the complete design, the **VS Gate Pro Front Trays**, are used, along with the depth-reduced **VS Gate Pro Rear Trays** in the upper area, and the full-depth **VS Gate Tray** in the lower portion of the cabinet. The result is even better access to the lower storage level.



VS TAL® Gate Pro - reduced height

VS Gate Rack VS TAL® Gate VS TAL® Gate Pro H1 variants

All **VS Gate** tall-cabinet solutions can also be used in base cabinets in the low **H1 variant**.

Compatibility with the VS Gate Flex components and the **VS ADD® Box** and **VS ADD® Separator** modules is also assured for individual interior organisation.



VS TAL® Gate Pro, H1 variant

Colour variants

The VS Gate products are available in the colours WHITE, SILVER and LAVA.



white



silver



lava



FURTHER INFORMATION AS WELL AS INSTALLATION INSTRUCTIONS AND VIDEOS:

WWW.VAUTH-SAGEL.COM

CONTACT: VS@VAUTH-SAGEL.COM

LAST UPDATED MAY 2023

© BY VAUTH-SAGEL | ALL RIGHTS RESERVED

